

# RTC CUP Test Area

## Appendix No. 1. Description, Technical Features, Configuration.

Three sectors of the test area: Maze, Field, Tower.

### 1. Maze

Maze is the main part of the test area, which contains cells with obstacles and tasks. The configuration of the Maze is to be changed before each competition.

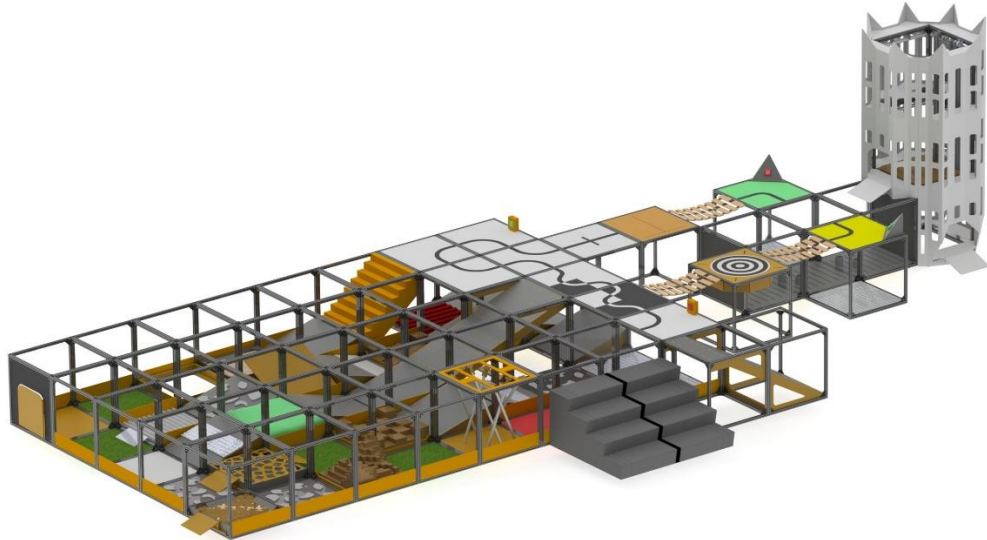

Figure 1.1 Example of the Maze configuration.

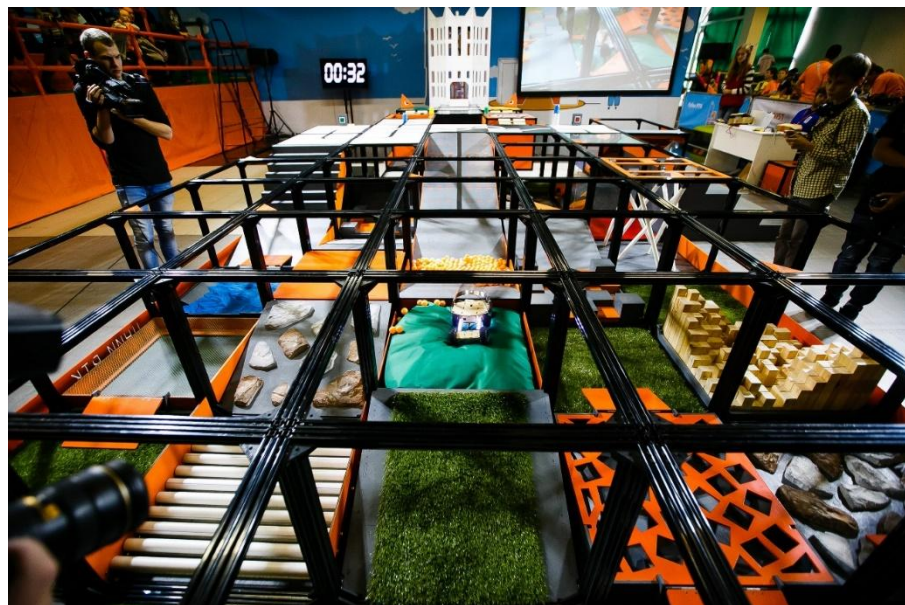

Figure 1.2 The Maze at the Robofinist 2016

## Tests and Tasks in the Maze

1.1. The **Door** opening both ways  $90^\circ$  (by pulling and pushing) with a bar handle (Figure 2). Door dimensions are  $480 \times 480 \times 8$ . When pushed by a robot, the door gets blocked by a stopper fixed inside the Maze and is set in an open position at  $90^\circ$ .

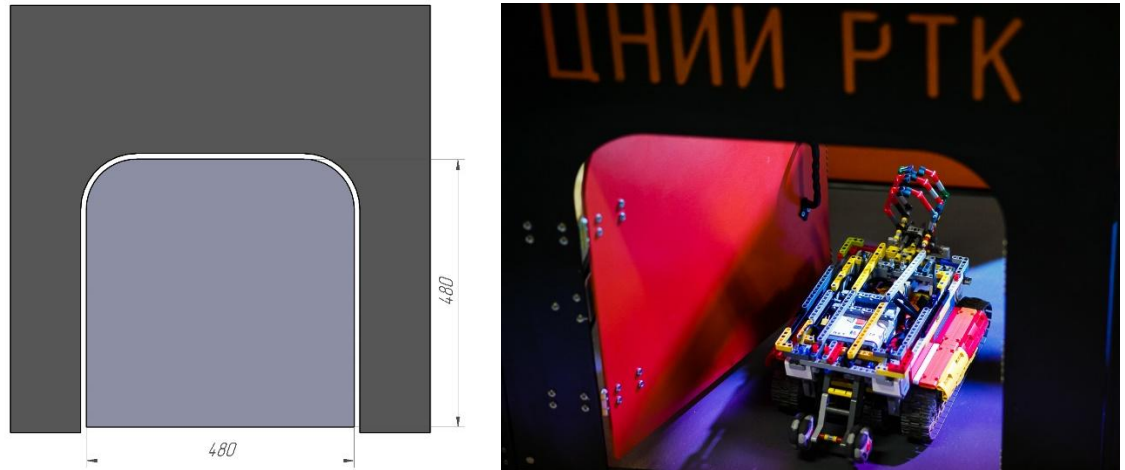

Figure 2. Door

1.2. Inside the Maze there may be randomly arranged **Inclined Surfaces** (Figure 4) at  $15^\circ$  slope angle and of  $740 \times 690 \times 200$  dimensions.

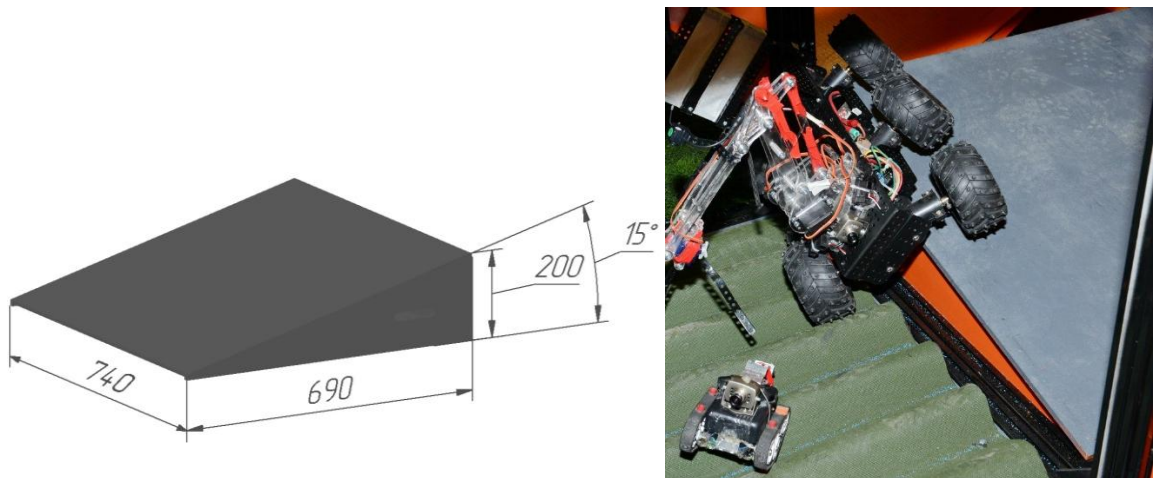

Figure 4.  $15^\circ$  Inclined Surface

The Inclined Surface at  $20^\circ$  slope angle (Figure 5) and of  $500 \times 250 \times 100$  dimensions is set against boxes.

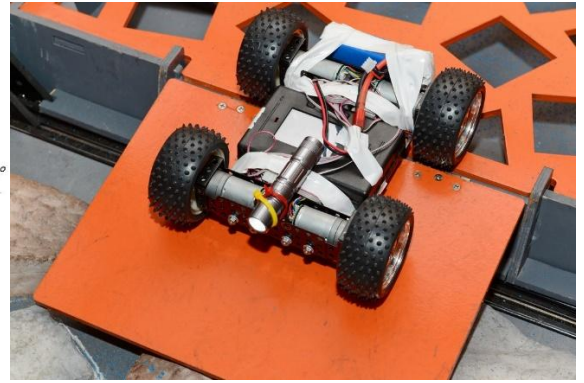
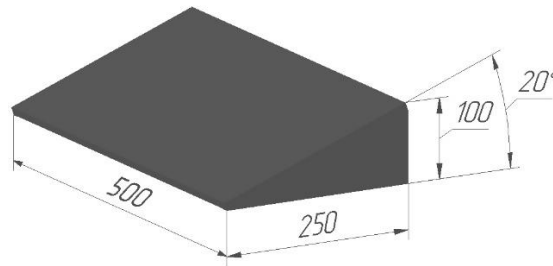

Figure 5. 20° Inclined Surface

Inclined Surfaces are designed to demonstrate the balance of the gravity center and capacity of a roving robot to cross over inclined sectors.

Inclined Surfaces may be combined in different ways: in groups of two or four, with co-directed or differently directed slopes (Figure 5). The capability to cross over such slopes demonstrates the agility of a robot.

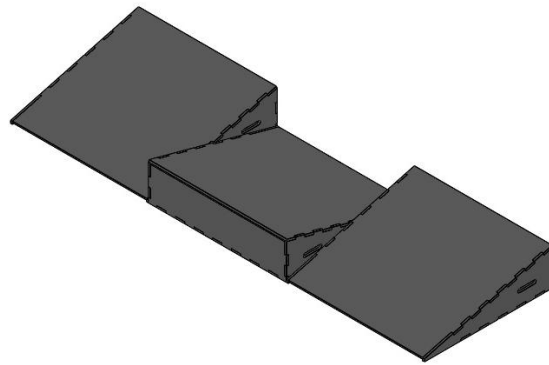

Figure 6. Possible Combination of Inclined Surfaces

1.3. **Ice** is a slippery fluoroplastic tile attached to a plywood sheet (Figure 7). Plate dimensions are 740x740x10. Multipurpose lubricant WD-40 is applied on the surface to increase slipperiness.

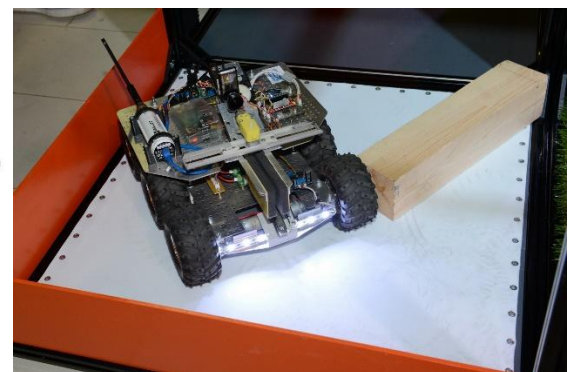
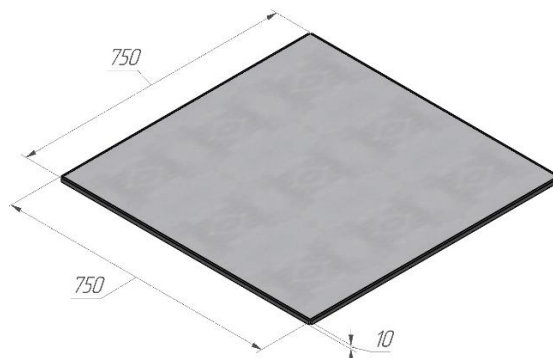

Figure 7. Ice

The Ice section is used to test the wheels/tracks traction with the surface.

1.4. The **Grass** is a sector with artificial grass made of polypropylene, the pile length is 40 mm (Figure 9). The coating is affixed to a plywood sheet. Sector dimensions are 740x740x50.

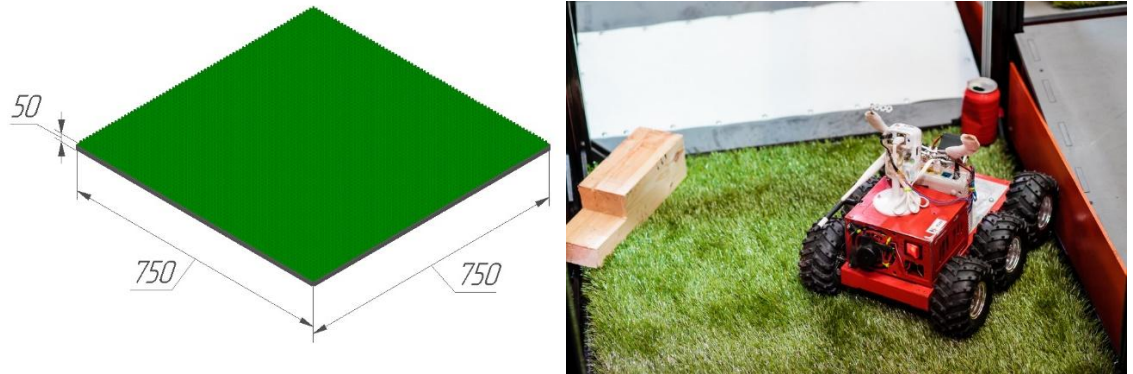

Figure 9. Grass Sector

Artificial grass serves to demonstrate integrity and durability of the robot's structure, as well as its passing ability in the natural environment.

1.5. The **Stones** sector consists of plywood with pieces of broken stones attached to it. The stone pieces have sharp angles and significantly vary in height (Figure 10). The average height of stone layer is 40 mm. Sector dimensions are 740x740x50.



Figure 10. Stones Sector

The Stones sector is designed to demonstrate the robot's passing ability through rough terrain, its engine capacity and suspension load capacity.

1.6. The **Sand** sector is a box filled with silica sand fractions of 0.2 - 2.5 mm (Figure 11). Box dimensions are 720x720x30. The height of sand layer varies from 20 to 30 mm. Inclined ramps are mounted inside the box and inclined surfaces are affixed outside the box (Figure 5).

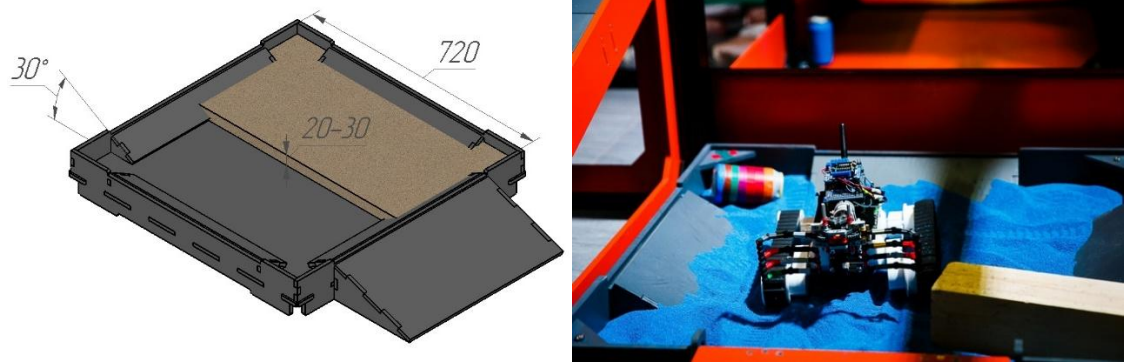

Figure 11. Sandbox

The Sandbox is designed to demonstrate the robot's passing ability through crumbling surfaces, its durability, breakage rate under the external influences typical for a real situation.

1.7. **The Ball Pool** is a triangular deepening with two slopes (Figure 12). The deepening is filled with 300 ping-pong plastic balls (40 mm in diameter) and 6 tennis balls (65 mm in diameter). Slopes dimensions are standard: 740x690x200. The depth of balls layer varies from 40 to 100 mm.

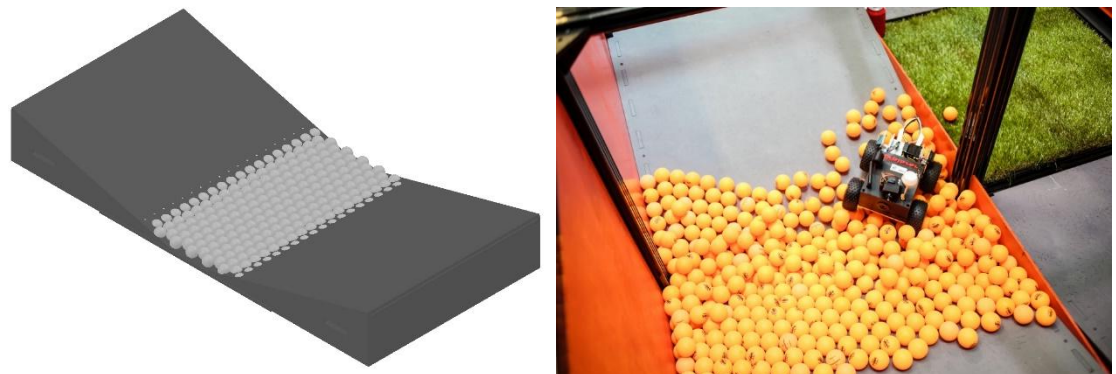

Figure 12. Ball Pool

This sector serves to demonstrate the high passing ability of a robot; this is the most complicated test sector for this parameter on the proving ground. High agility and good robot manipulation skills are also required to pass this task.

1.8. **The Fog** sector is filled with intensive fog (Figure 14). It consists of several connected sections (2-3 cells) with a plywood floor (8 mm wide) and transparent plexiglas ceiling. Sections have three "cat door" entrances which are 500x500 arched doorways curtained by rubber strips (50 mm wide). Sections are additionally sealed by mounting adhesive tape. Therefore the smoke penetrates sparingly. Smoke is generated by a smoke machine (standard stage equipment) mounted inside the section (on the floor). Additional obstacles are randomly fixed on the floor of the section: 6-8 plexiglas cans of 100 mm diameter. The minimum travel width between the cans is 450 mm.

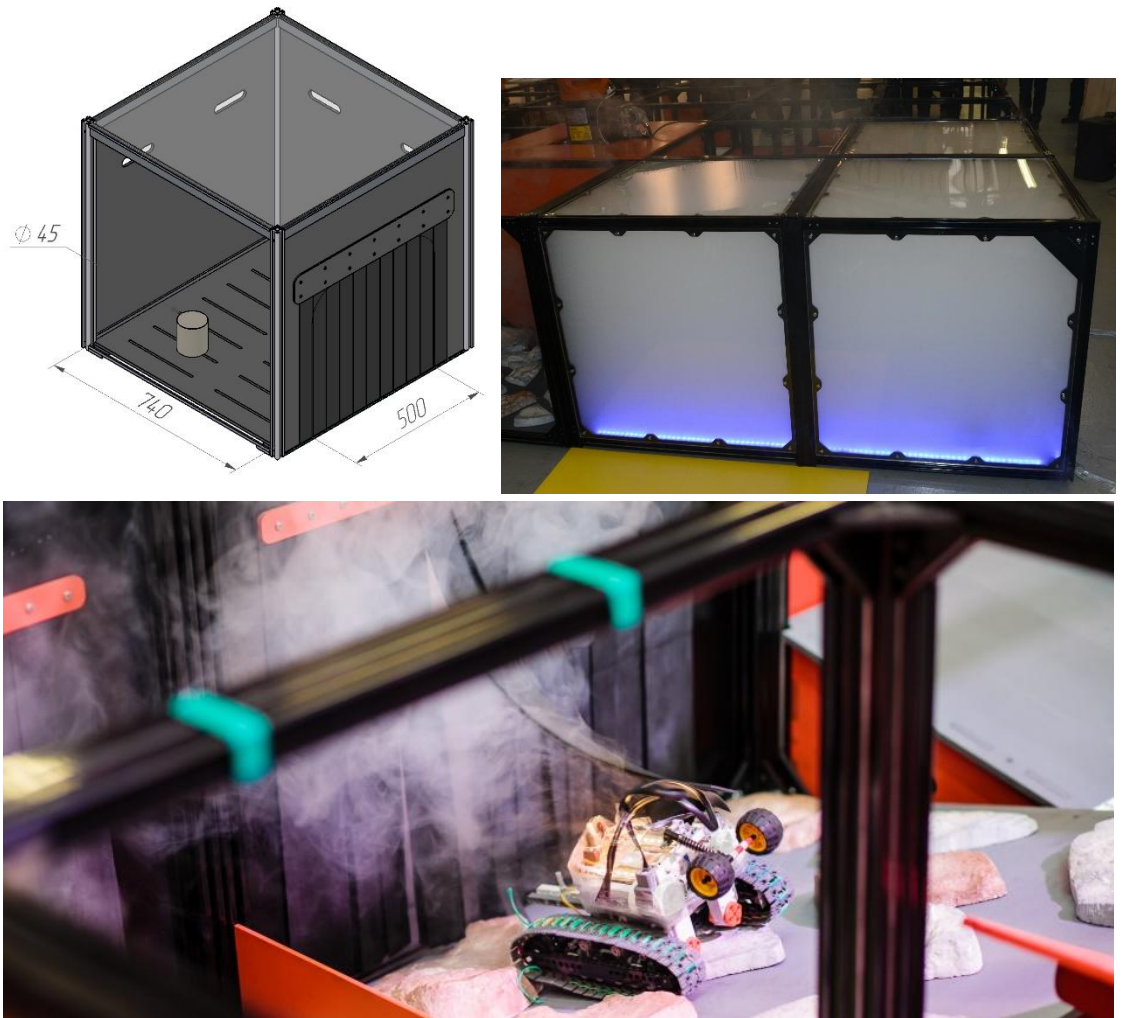

Figure 14. Fog

This sector serves to assess orienteering skills and the robot's agility in limited visibility conditions. Robots may be equipped with flashlights, headlights or other accessories.

1.9. The **Button** is a standard switch for a lamp (Figure 16). When switched on, the lamp in the **Fog** sector flashes on. The Button is placed 100 mm above the floor.



Figure 16. Button

Button is used to demonstrate the following characteristics of the robot's manipulator: accuracy, pressure, working range.

1.10. **Expanded Clay** is a sector consisting of a box filled with 10-20 mm fractions of expanded clay (Figure 17). Box dimensions are 720x720x30. The height of expanded clay layer varies from 20 to 30 mm. Inclined ramps are mounted inside the box and inclined surfaces are affixed outside the box (Figure 5).



Figure 17. Expanded Clay

This sector is to demonstrate the robot's ability to pass through crumbling surface. Since the expanded clay is lightweight, the more the robot manoeuvres in a cell, the more it digs into the expanded clay layer.

1.11. The **Net** sector consists of 740x740 mm frame with a net stretched on it (Figure 18). Tension is weak and net sags slightly. The mesh size is 1 sq cm. The Net is made of thin kapron cord by knot weaving.

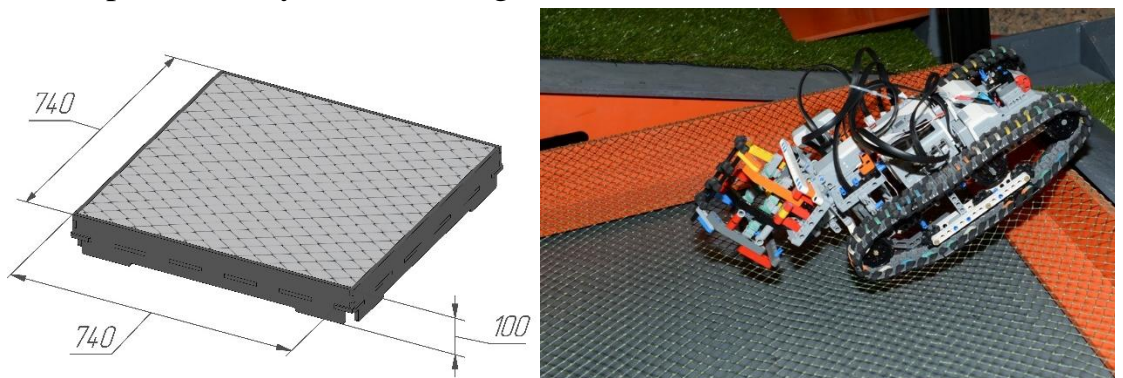

Figure 18. Net

Passing through this sector serves to identify the robot's design defects: protruding and sticking parts, poorly distributed balance.

1.12. The **Grass Slope** is a typical 15° inclined surface with artificial grass on it. The surface dimensions are 740x690x200 (Figure 19). Pile length is 40 mm. The width of the artificial grass layer may vary from 200 mm to the total width of the slope.

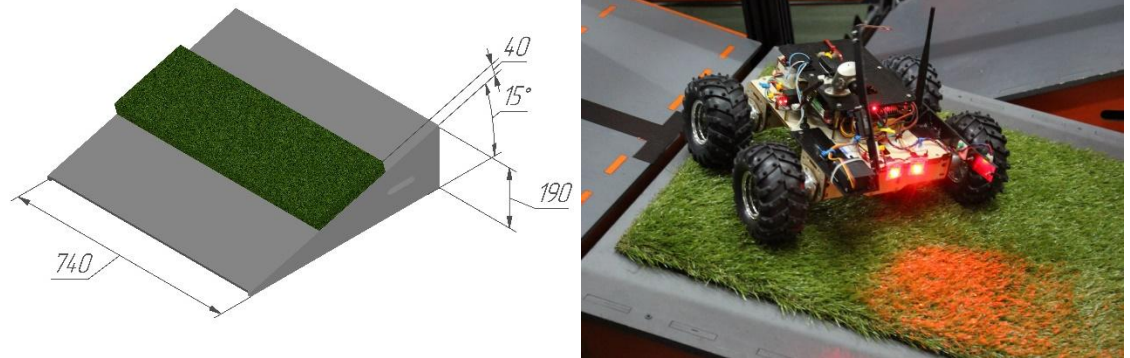

Figure 19. Grass Slope

The passage through such surface demonstrates the traction quality and engine capacity, as well as the robot's capability to cross over inclined rough terrain.

1.13. The **Swamp** is a polyether bag stowed in the cell and half-filled with polystyrene balls of 4-6 mm diameter. The bag is pressed by standard 15° inclined surfaces serving as exit slopes. 20° inclined surfaces are attached to the slopes inside for robots to descend to the bag (Figure 20).

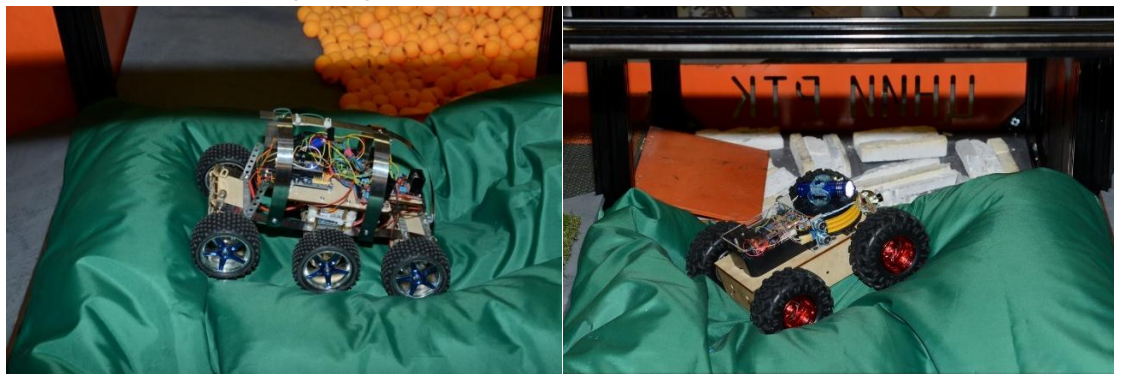

Figure 20. Swamp

In this sector the robot can demonstrate its ability to cross over viscous substance with its surface changing in response to the robot's movements.

1.14. The **Broken Floor** is a grid with holes of various shapes, with a diameter of 70-80 mm.



Figure 20. Broken Floor



1.15. The **Roof** is a roof tile fixed on a plywood floor. Overall dimensions of the test - 740x740x40.



Figure 21. Roof

1.16. The **Seesaw** - plywood, fixed on the axis, passing in the middle of the cube-cell. The seesaw is located at a standard inclined height of  $15^\circ$ . The maximum tilt angle of the tile is about  $30^\circ$ .

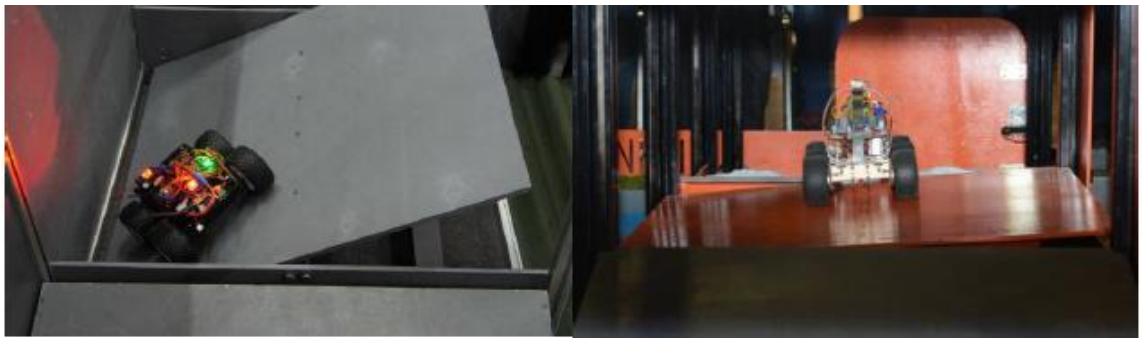

Figure 22. Seesaw

1.17. The **Wood Pile** - a construction of wooden bars 50x50mm of different lengths, installed vertically, tightly to each other.



Figure 23. Wood Pile

1.18. The **Blockage** presents itself a cell with multidirectional polypropylene pipes attached to a cell ceiling. The pipes block the path through the cube. The pipes can be lifted or moved aside.



Figure 24. Blockage

1.19. The **Straight ramps** – cell filled with rectangles of different heights  $\pm 50$  mm.



Figure 25. Straight ramps

1.20. The **Align ramps** – cell filled with triangles with inclination of  $15^\circ$ .



Figure 24. Align ramps

1.21. The **Inclined Surface with ramps** is a standard inclined surface with  $15^\circ$  slope, with dimensions of 740x690x200 mm, filled with triangles with  $15^\circ$  slope.

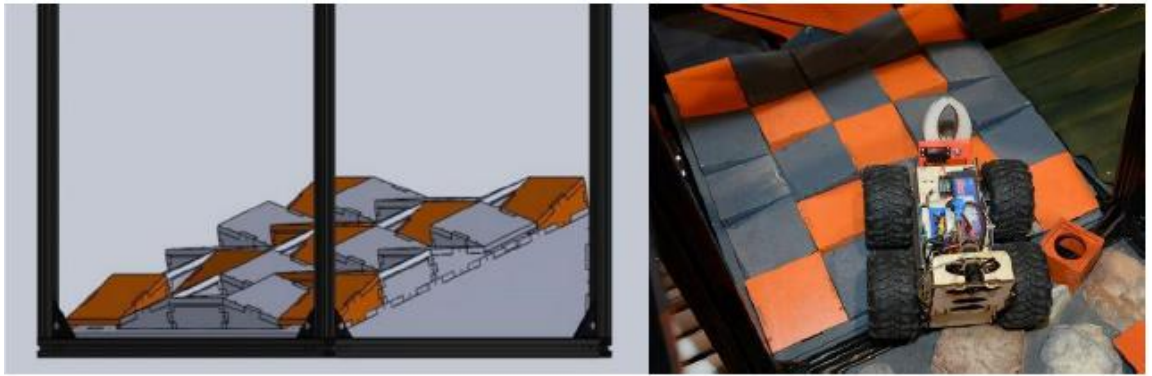

Figure 25. Inclined Surface with ramps

1.22. The **Sand/Gravel Slope** is a standard inclined surface  $15^\circ$ , with dimensions of  $740 \times 690 \times 200$  mm. A box filled with sand/gravel fixed inside the Slope. Box also has ribs fixed inside to prevent shedding of the contents. Depth of the box - 40 mm.



Figure 26. Sand/Gravel Slope

1.23. The **Spikes** is a standard cell with a wooden bar bits fixed on the plywood tile. Wooden bar bits dimensions are  $50 \times 50 \times 70$  mm.



Figure 27. Spikes

1.24. The **Rails** - a plywood tile, in which rows of holes are made on two opposite sides. Stumps protruding from two wooden bars are inserted into the holes to hold bars into place. One rail dimensions are  $70 \times 70 \times 740$  mm. The rails are adjusted to the width of the robot base before the start.

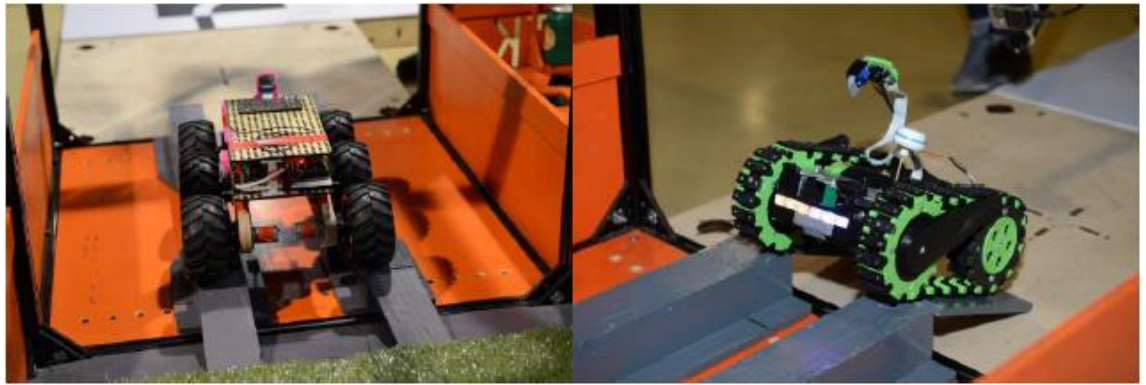

Figure 28. Rails

1.25. The **Logs** present itself a suspension bridge made of thin wooden planks hanging loosely. The width of one plank is 65 mm, the distance between planks fluctuate from 0 to 65 mm.

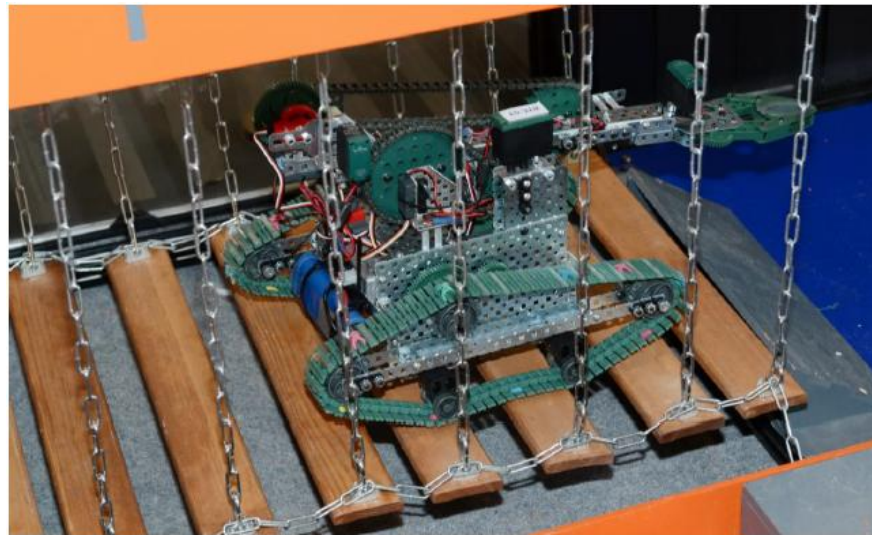

Figure 29. Logs

All planks are connected by a metal chain. The width of the bridge is 500 mm. The distance between the bridge and a floor is 80 mm.

1.26. The **Hatch** is a test located on the 2nd floor of the maze, in a cell with a hatch instead of the floor, as well as with a special beacon on top. When you remove the beacon – 4 second timer starts. After a time runs out the hatch opens, and if the robot was still in the cell it falls down on the floor (which is covered with foam for soft landing).



Figure 30. Hatch

1.27. The **Hypno Disk** is a rotating disk with 650 mm diameter fixed on the top of the cell. Disk is made from plywood, surface covered with vinyl.



Figure 31. Hypno Disk

1.28. The **Trench** is a plywood tile with two oblong rectangular trenches 40 mm deep. The trench length is 670 mm, width - 140 mm. One trench is filled with tennis balls (65 mm in diameter), the second is empty. The dexterity task here is to capture ball and put it into second trench.

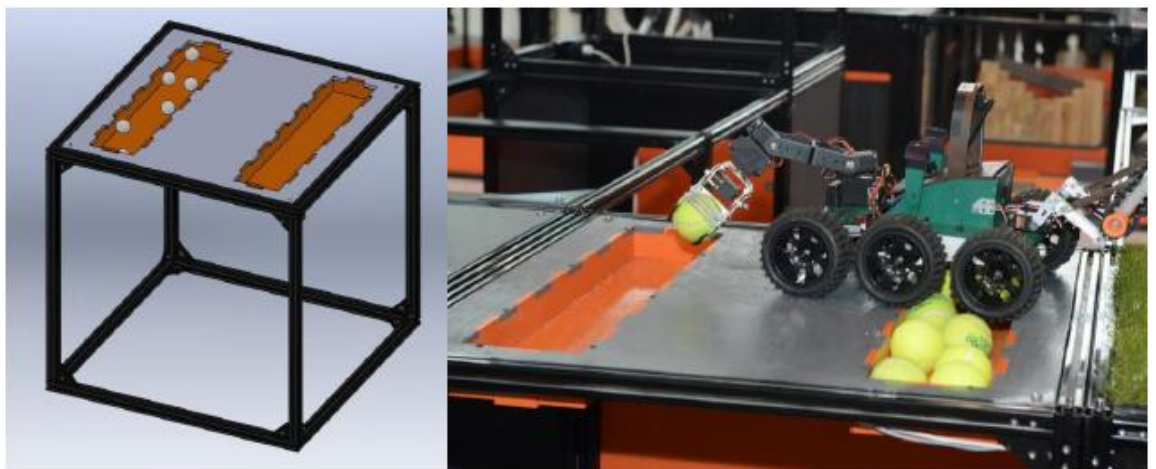

Figure 32. Trench

1.29. The **Ribs** is a plywood tile with alternating rectangles in a chessboard pattern with dimensions of 355x120x40 mm.

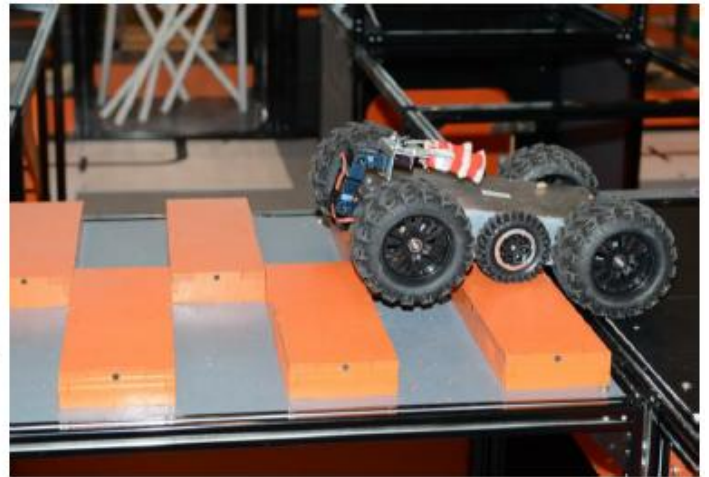

Figure 33. Ribs

1.30. The **Suspension bridge** is made from wooden planks 300x65x12 mm fixed on straps 30 mm wide. The gap between planks is 15-20 mm. The length of the bridge varies, width of the bridge is 400 mm.



Figure 34. Suspension bridge

1.31. The **Inclined Surface 20°** consist of 2 cells, the entrance to which is the standard inclined surface 15°. Inclined surface 20° leads to the 2<sup>nd</sup> floor of the maze.



Figure 35. Inclined Surface 20°

1.32. The **Inclined Surface 30°** leads from the 1<sup>st</sup> floor to the 2<sup>nd</sup> and occupies two standard cells.



Figure 36. Inclined Surface 30 °

1.33. The **Small Staircase** is located in a standard cell and leads to 2<sup>nd</sup> floor. The staircase has eight steps each 75 mm high and 90 mm deep. The stairs starts with a standard inclined surface of 15 °.



Figure 37. Small Staircase

1.34. Staircase with overall dimensions of 1480x1220x620 mm, each step 150 mm high and 340 mm deep.

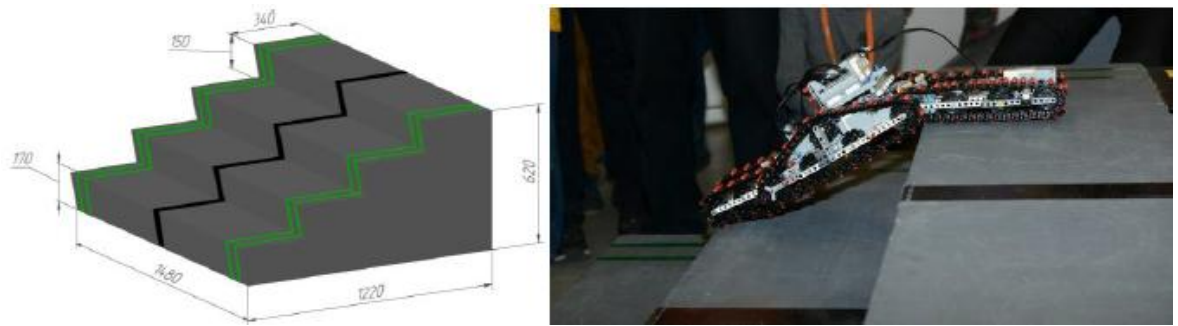

Figure 38. Staircase

### 1.35. Line following

The line is 50 mm wide, black on white background. Each tile goes into account separately.

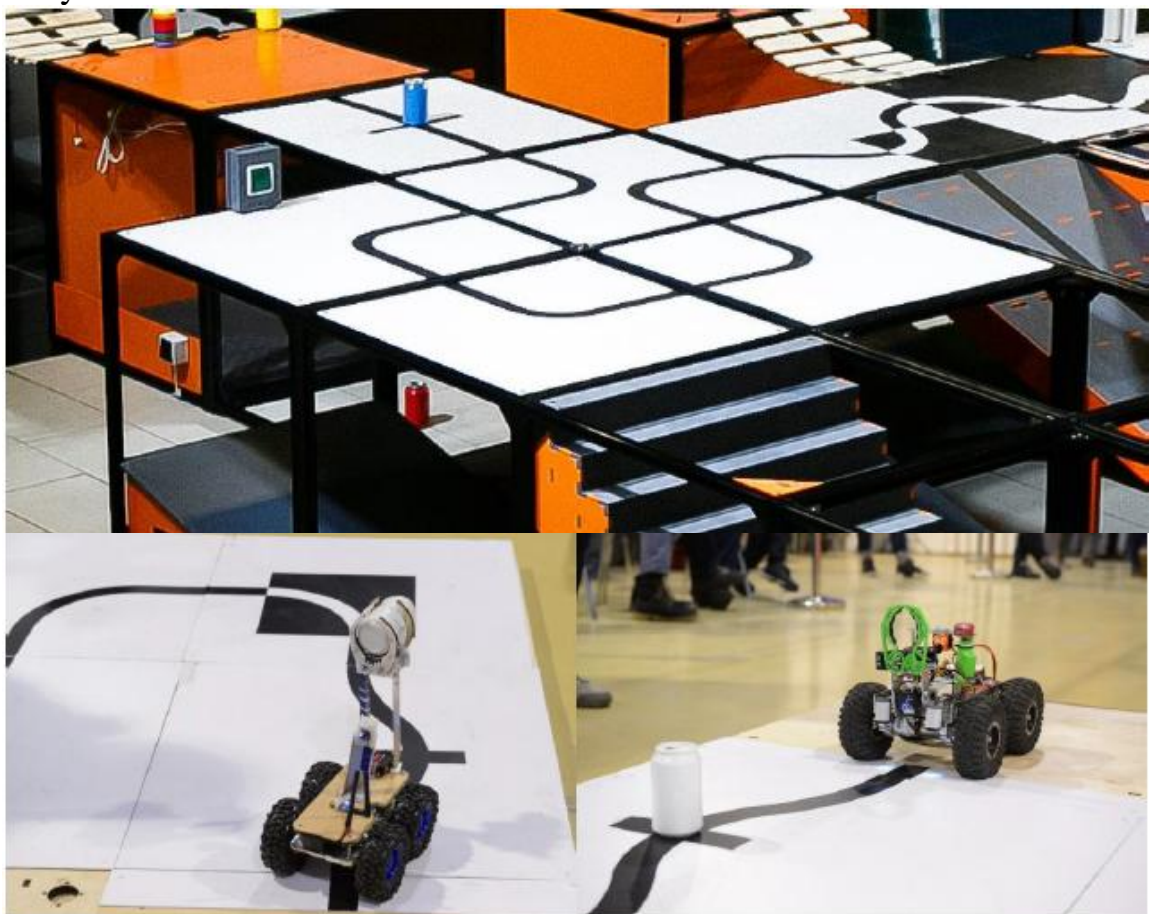

Figure 39. Line tiles

1.36. For the **Beacons Collection** 0.33 1 aluminum cans are used. Beacons are painted in one of the following colors: red, blue, green, yellow. The robot's task is to grip and lift the beacon or carry it to the respective color zone in any other way. The color zone is marked with a whole-colored rubberized cloth of red, blue, green, yellow or white color spread on the floor.

Beacons delivery allows to assess accuracy and agility of a robot and functionality of its manipulator.



Possible variation of beacons and zones allocation in the Maze is shown in Figure 21.

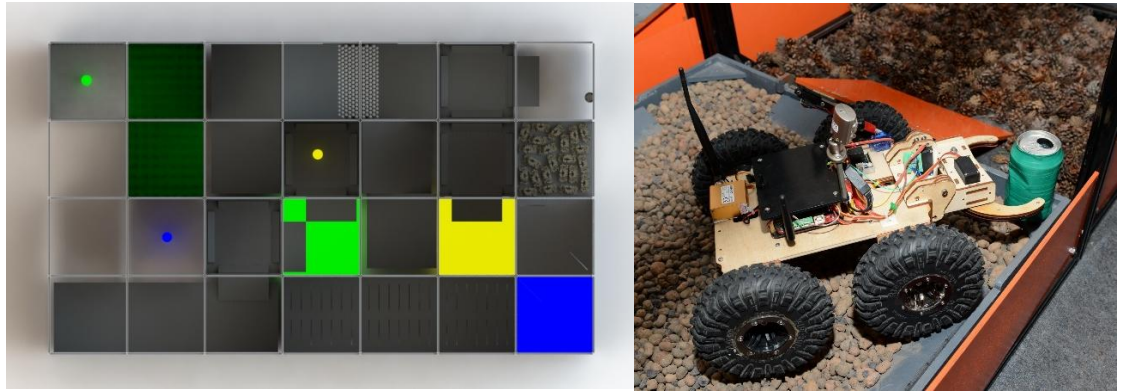

Figure 40. Possible Beacons and Zones Allocation in the Maze

**High Beacon** is a standard beacon located at an elevation representing a miniature copy of the Tower: 160 mm in height and 90 mm in diameter (Figure 22).

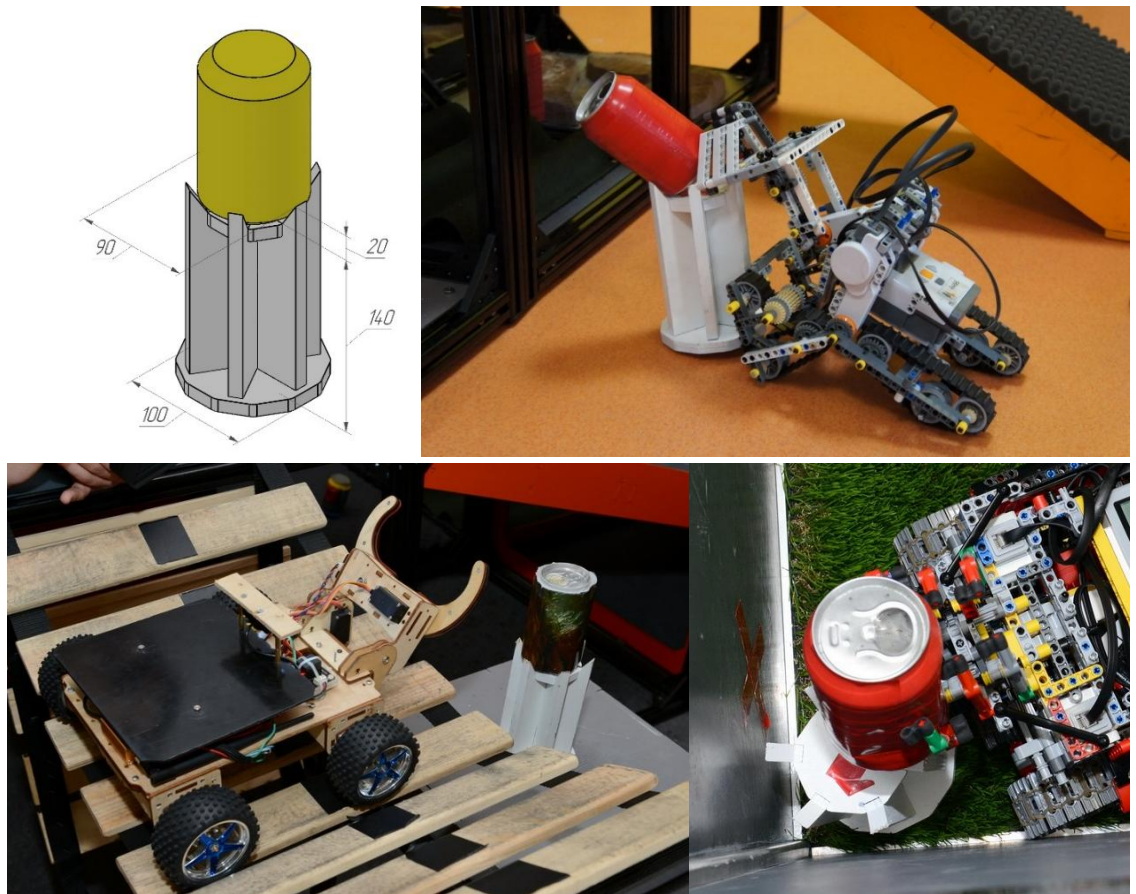

Figure 41. Tower with Beacon

Beacon's displacement from the tower proves the high functionality of the robotic arm.

1.37. **Flag Capture** is a task where each robot is assigned a red or green color before the start, depending on color of the starting gate (indicated by arrows in the figure). There are buttons of two colors: red and green, when pushed, light up the

Tower with red or green light accordingly. The robot, whose color tower glows at the end of the attempt, receives additional points. The rule works for both categories, even if there is only one robot on the test arena at a time.

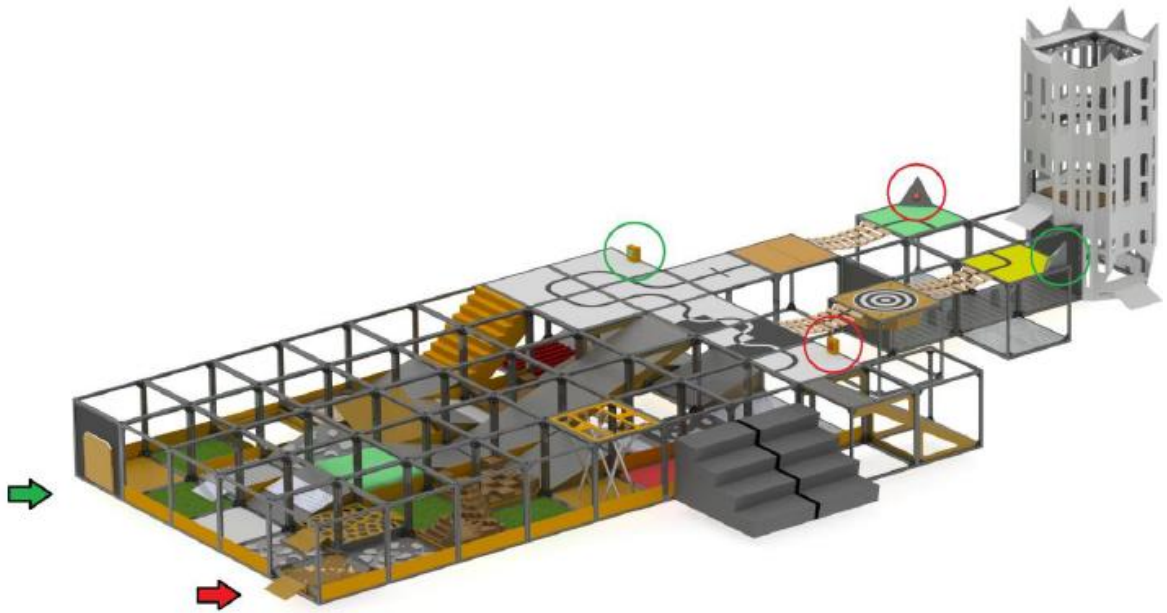

Figure 42. Buttons and starting gates

### 3 Tower with elevator

The Tower is 2,4 m high and present itself final task of the test area.

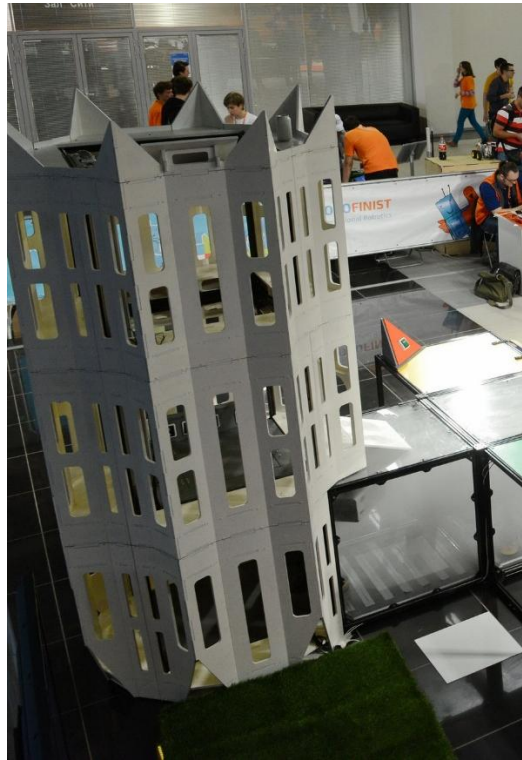

Figure 43. Tower

The arch, leading to the elevator platform, is 400mm wide and 360 mm high, dimensions of the platform is 720x600 mm.



Figure 44. Elevator

Test area contains 10-15 tasks with high level of difficulty. By performing 3 of this tasks successfully team gets 3 tokens with a special symbols, which would be used for activating elevator by pressing 3 buttons on the platform.

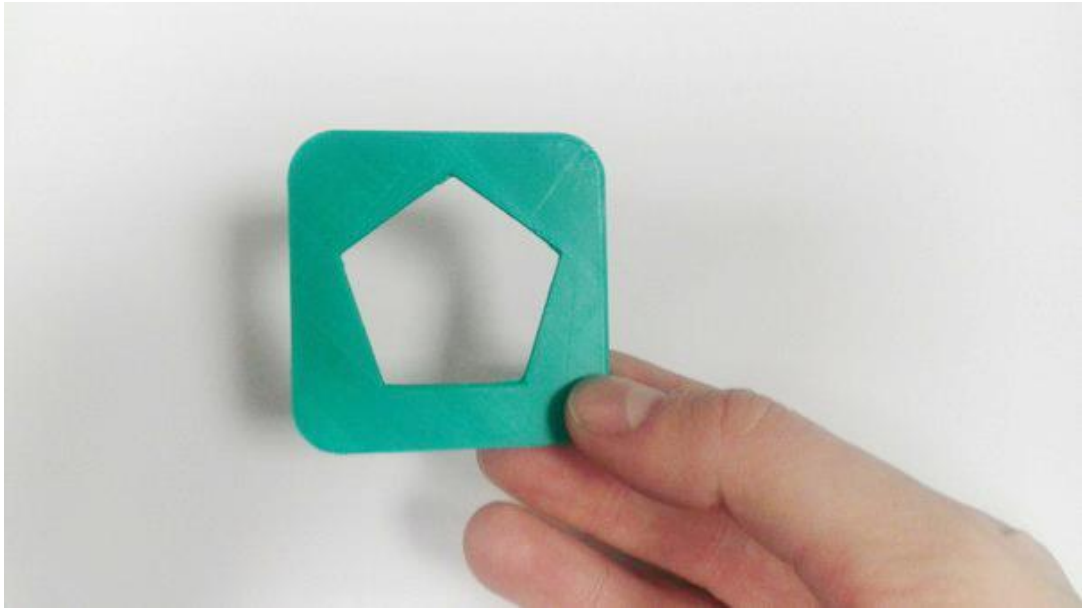

Figure 45. Code tokens

After pressing buttons with according symbols on them in its right positions, robot should press a button with yellow check mark to activate elevator.



Figure 46. Buttons with symbols

If the code was put in **correctly** – elevator lifts robot to the top, and team gain great amount of points. Out of the top robot can perform “Trust fall” from 2,4 m high and gain even more points - and twice of that, if it could keep moving without immediate repair.

If the code was put in **incorrectly** – elevator lifts up to 1,8 m, the floor of the platform opens up and robot falls down to the ground floor of the tower.

In both ways the spot in witch robot would be falling is covered with foam rubber material.



Figure 47. Trust fall



#### **4 Stand Configuration**

The test area configuration and obstacles allocation shall be reported on the day of the competition.

The final list of obstacles and points given for their passing shall be reported one week prior to the competition start.

Certain details, obstacles and their allocation may be changed directly before the competition due to unforeseen circumstances.